

Article number: 20194B48B482SW

Description: E+G

T-angel clamps GN194-B48-B48-2-SW

Measures

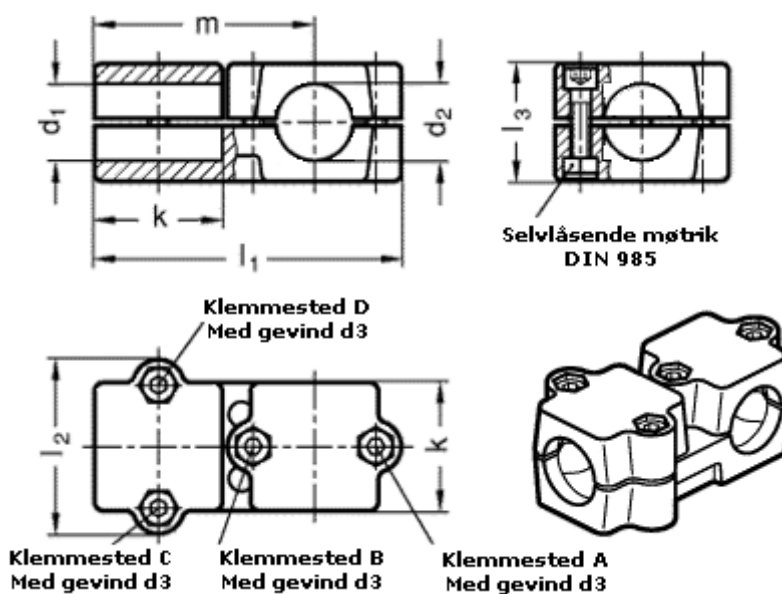

d1 = 48
d2 = 48
d3 = M10
k = 76
l1 = 176
l2 = 98
l3 = 70
m = 126